

Product Parts Breakdown

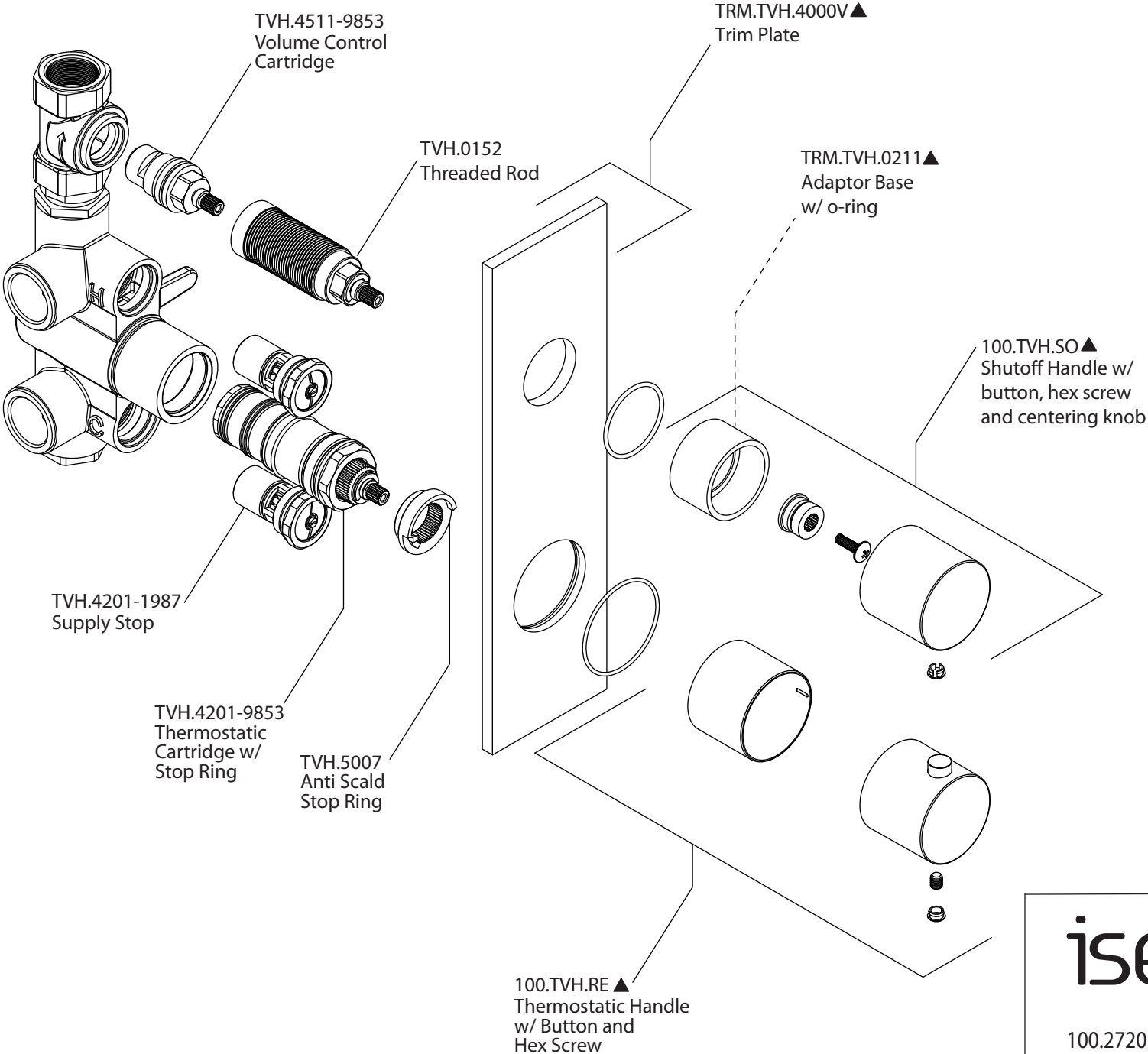

isenberg
innovation+design

100.2720

Ver 2.53