

Product Parts Breakdown

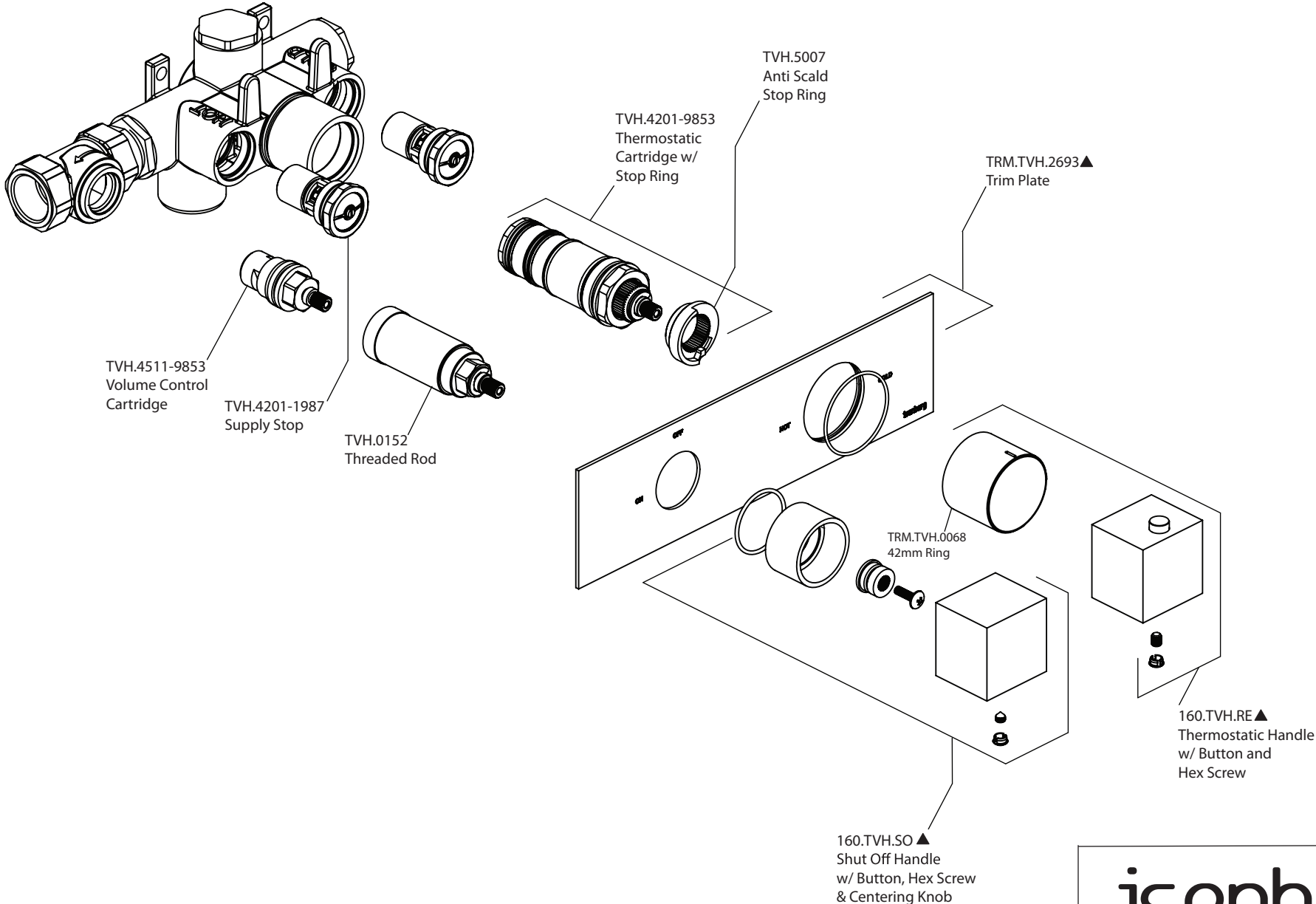

isenberg
innovation+design

160.2693

Ver 2.53